

## DATA SHEET: ACCESSORIES INDUSTRIAL POWER RELAY RT AND XT

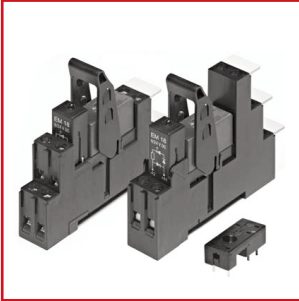

- For Industrial Power Relay RT and XT pinnings 3.5mm / 5mm; relay height 15.7 mm
- New retainer clip with ejection function
- Easy replacement of relays on a densely packed DIN rail
- No reduction of protection class or creepage/clearance with plastic retainer
- Simple plug-in indicator- and protection modules
- White snap-on marking tags
- RoHS compliant (Directive 2002/95/EC)

## PREMIUM SOCKET WITH SCREWLESS TERMINALS FOR DIN RAIL MOUNTING

RT7872P Premium socket, logical terminal arrangement

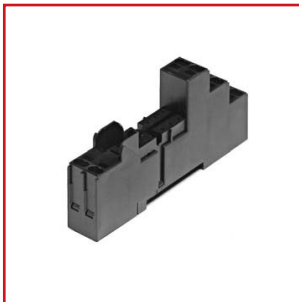

- Screwless Clamps
- Mounting of solid wires without tool
- Double Clamps per terminal
- Jumper links for interconnection
- Open coil circuit for active modules
- Logical terminal arrangement

## DIMENSIONS

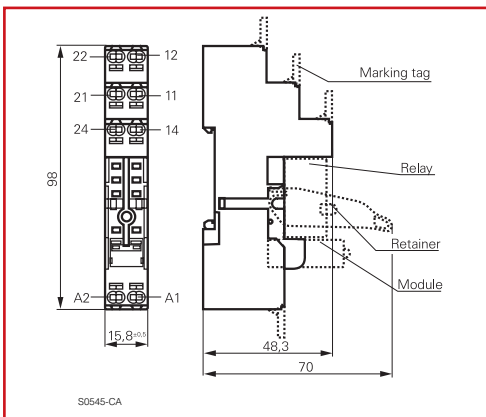

## DERATING CURVE

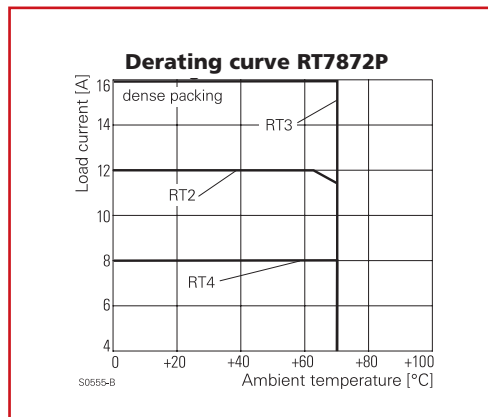

## APPROVALS

VDE REG.-No. 6106, cRUus E135149

**TECHNICAL DATA**

Technical Data	
Rated current	2 x 8 A, 16A*)
Rated voltage / max. switching voltage AC	240 / 400 VAC
Dielectric strength coil-contact circuit	5000 V <sub>rms</sub>
open contact circuit	1000 V <sub>rms</sub>
adjacent contact circuits	2500 V <sub>rms</sub>
Clearance / creepage coil-contact circuit	≧ 10 / 10 mm
Material group of insulation parts	IIIa
Insulation to IEC 60664-1	
Type of insulation coil-contact circuit	reinforced
open contact circuit	functional
adjacent contact circuits	functional
Rated insulation voltage	250 V
Pollution degree	2
Rated voltage system	230 / 400 V
Overvoltage category	III
RoHS-Directive 2002/95/EC	compliant
Protection DIN 40050	IP20
Ambient temperature range for mounting/handling	-20...+70°C
in operation	-40...+70°C
Terminals	screwless
Wire strip length	12 mm
Wire cross section	
solid wire	1 x 0,75 / 1 / 1,5 mm <sup>2</sup>
with standard isolation (no oversize isolation)	2 x 0,75 / 1 mm <sup>2</sup> 2 x 1,5 mm <sup>2</sup>
stranded wire	1 x 0,75 / 1 / 1,5 mm <sup>2</sup>
without bootlace crimp	2 x 0,75 / 1 mm <sup>2</sup> 2 x 1,5 mm <sup>2</sup>
without bootlace crimp with standard isolation	2 x 1,5 mm <sup>2</sup>
with bootlace crimp	1 x 0,75 / 1 mm <sup>2</sup>
with bootlace crimp without isolation	2 x 0,75 mm <sup>2</sup> 1 x 1,5 mm <sup>2</sup>
or min 18 mm long	

For stranded wires with braids 0.05 mm or smaller the use of bootlace crimps is recommended. When using stranded wires without bootlace crimp the clamp must be opened during insertion.

Insertion cycles	A (10)
Max. Insertion Force total	100 N
Mounting distance	≧ 0, dense packing
Weight	36 g
Packaging unit	10 pcs

\*) For 1 pole relays (16 A) the relay terminals 11-21, 12-22 and 14-24 have to be bridged. Not suitable for bistable relays with 2 coils!

**Socket with screwless terminals for DIN rail mounting**

Type	Order No.
<b>RT7872P</b> Premium socket, logical terminal arrangement	RT7872P
Socket with screwless terminals, pinning 5 mm for DIN rail mounting	

**Accessories for RT7872P**

Type	Order No.
<b>RT17017</b> Plastic retaining clip, relay height 15.7	RT17017
<b>XT17017</b> Plastic retaining clip, relay height 25.5	XT17017
<b>RT170P1</b> Jumper link, max load 12 A	RT170P1
<b>YRT16040</b> Marking tag	YRT16040

**HOW TO USE / PRECAUTIONS**

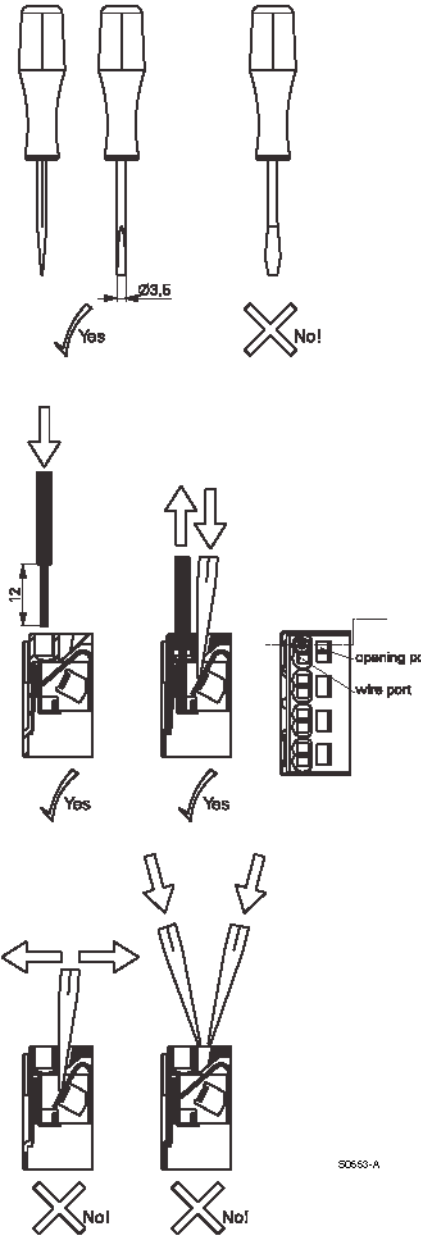

S0653-A

Jumper link

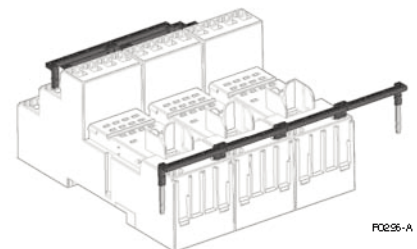

F0236-A

## SOCKET WITH SCREW-TYPE TERMINALS FOR DIN RAIL MOUNTING

**YRT78624** Socket with screw-type terminals, pinning 3.5 mm for DIN rail mounting

**YRT78626** Socket with screw-type terminals, pinning 5 mm for DIN rail mounting, logical terminal arrangement

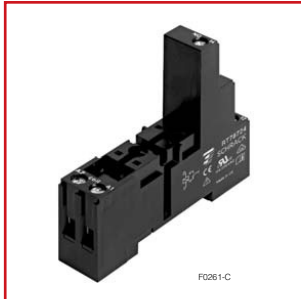

- Din-rail socket with logical setup of connections (input/output)
- High quality rising clamp terminals
- Captive combination terminal screws
- Jumper bars for interconnection

## DIMENSIONS

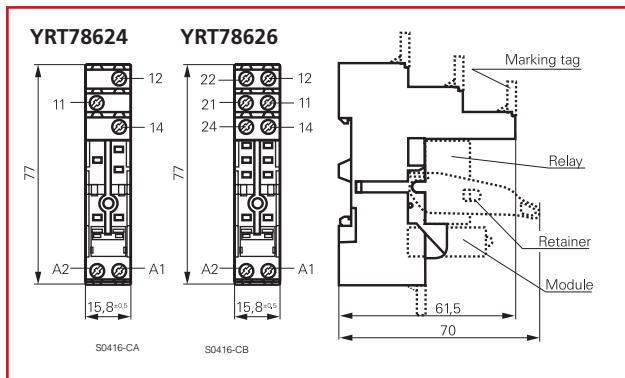

**YRT78725** Socket with screw-type terminals, pinning 5 mm for DIN rail mounting, conventional terminal arrangement

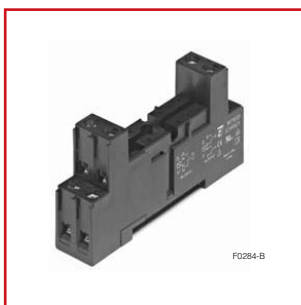

- Conventional terminal arrangement

## DIMENSIONS

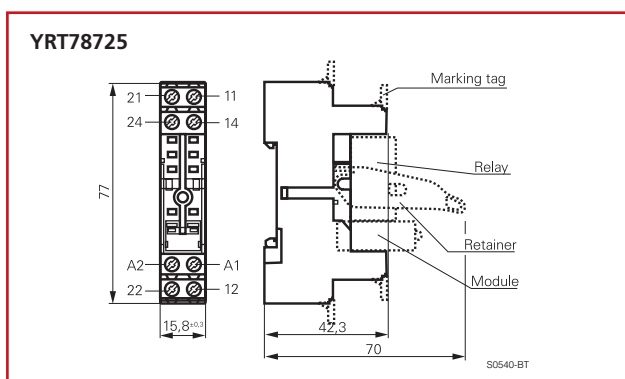

**DERATING CURVES**

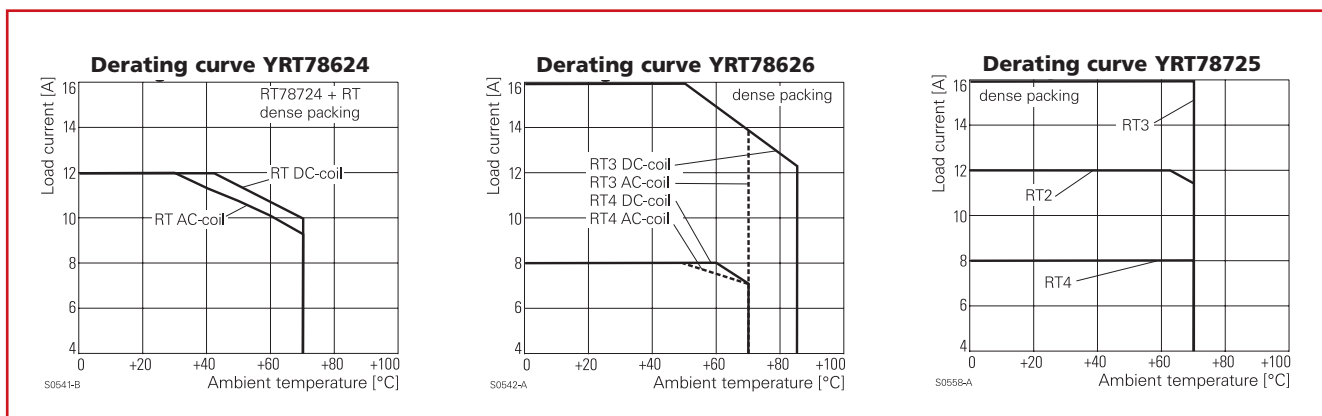

**APPROVALS**



**TECHNICAL DATA**

Technical Data		YRT78624 / YRT78626 / YRT78725
Rated current		12 A, 2 x 8 A, 16 A *)
Rated voltage / max. switching voltage AC		240 / 400 VAC
Dielectric strength coil-contact circuit		5000 V <sub>rms</sub> / 5000 V <sub>rms</sub> / 4000 V <sub>rms</sub>
open contact circuit		1000 V <sub>rms</sub> / 1000 V <sub>rms</sub> / 1000 V <sub>rms</sub>
adjacent contact circuits		2500 V <sub>rms</sub> / 2500 V <sub>rms</sub> / 2500 V <sub>rms</sub>
Clearance / creepage coil-contact circuit		≥ 10/10 mm / ≥ 10/10 mm / ≥ 4.7/4.7 mm
Material group of insulation parts		IIIa
Insulation to IEC 60664-1		
Type of insulation coil-contact circuit		reinforced / reinforced / basic
open contact circuit		functional
adjacent contact circuits		functional
Rated insulation voltage		250 V
Pollution degree		2
Rated voltage system		230 / 400 V
Overvoltage category		III
RoHS-Directive 2002/95/EC		compliant
Protection DIN 40050		IP20
Ambient temperature range for mounting/handling		-20...+70°C
in operation		-40...+70°C
Terminals		screw
Terminal screw torque acc. IEC 61984		0,5 Nm
max.		0,7 Nm
Wire cross section		
single wire		2 x 2,5 mm <sup>2</sup>
fine wire		2 x 2,5 mm <sup>2</sup>
with bootlace crimp (DIN 46228/1)		2 x 1.5 mm <sup>2</sup>
Insertion cycles		A (10)
Max. Insertion Force total		100 N
Mounting distance		≥ 0, dense packing
Weight		36 g
Packaging unit		10 pcs

Not suitable for bistable relays with 2 coils!

\*) For 1 pole relays (16 A) the relay terminals 11-21, 12-22 and 14-24 have to be bridged.

For 1 pole relays (12 A) the relay terminals 11-12-14 have to be connected to the socket terminals 21-12-24.

**Socket with screw-type terminals for DIN rail mounting**

Type		Order No.
<b>YRT78624</b>	Socket with screw-type terminals, pinning 3.5 mm for DIN rail mounting, logical terminal arrangement	YRT78624
<b>YRT78626</b>	Socket with screw-type terminals, pinning 5 mm for DIN rail mounting, logical terminal arrangement	YRT78626
<b>YRT78725</b>	Socket with screw-type terminals, pinning 5 mm for DIN rail mounting, conventional terminal arrangement	YRT78725

**Accessories for YRT78624, YRT78626, YRT78725**

Type		Order No.
<b>RT17017</b>	Plastic retaining clip, relay height 15.7	RT17017
<b>XT17017</b>	Plastic retaining clip, relay height 25.5	XT17017
<b>RT170R8</b>	Jumper bar, max load 12 A for connection of up to 8 RT sockets	RT170R8
<b>YRT16040</b>	Marking tag	YRT16040

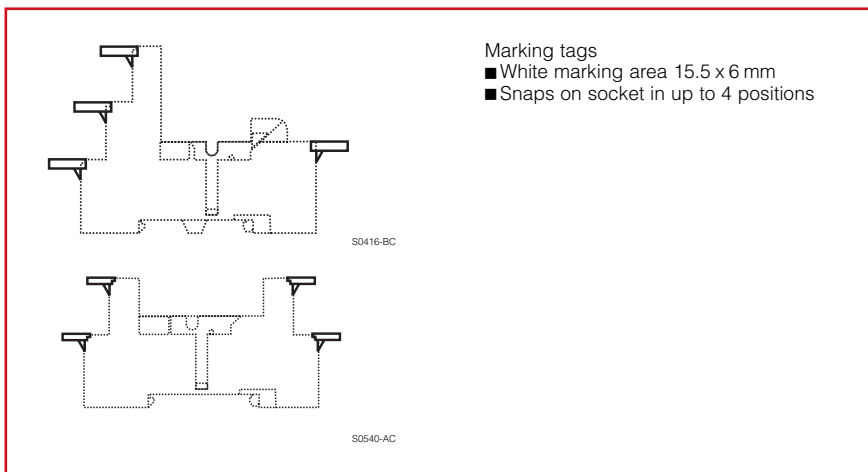
 **MARKING TAGS**

 **HOW TO USE**

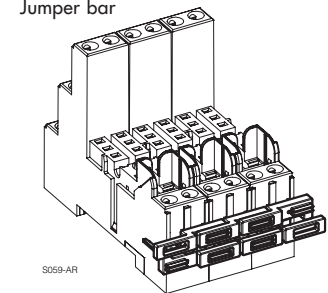
Jumper bar



LED- AND PROTECTION MODULES FOR YRT78624, YRT78626, YRT78725



Easy insertion of module into the socket

Wiring in parallel to the coil

Type			Order No.
<b>YMF DG230</b>	EM09	Protection diode (standard, A1+, A2-)	YMF DG230
<b>YMRCW024</b>	EM02	RC-network 6...60 VAC	YMRCW024
<b>YMRCW030</b>	EM03	RC-network 110...230 VAC	YMRCW030
<b>YMLVAW024</b>	EM04	Varistor 24 VAC	YMLVAW024
<b>YMLVAW030</b>	EM05	Varistor 230 VAC	YMLVAW230

LED

<b>YMLRD024A</b>	EM18	red LED 6...24 VDC w. prot.diode (std, A1+, A2-)	YMLRD024A
<b>YMLGD024</b>	EM12	green LED 6...24 VDC w. prot.diode (std, A1+, A2-)	YMLGD024
<b>YMLRD024</b>	EM08	red LED 6...24 VDC w. prot. diode (A1-, A2+)	YMLRD024
<b>YMLRA024</b>	EM07	red LED 6...24 VDC/VAC	YMLRA024
<b>YMLGA024</b>	EM11	green LED 6...24 VDC/VAC	YMLGA024
<b>YMLRW230</b>	EM06	red LED 110...230 VAC	YMLRW230
<b>YMLGW230</b>	EM10	green LED 110...230 VAC	YMLGW230

SOCKETS FOR PCB MOUNT RP78601/602

**RP78601** Socket with PCB terminals, pinning 3.5 mm

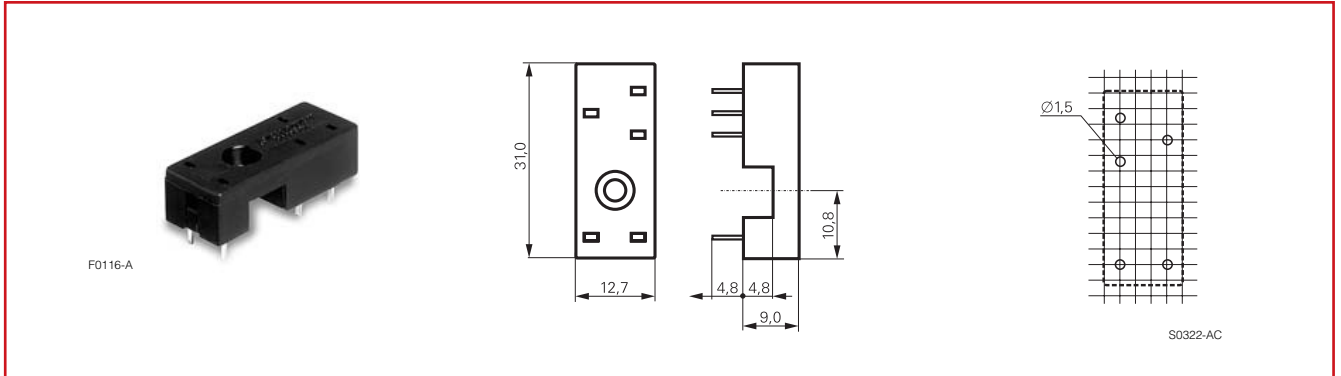

**RP78602** Socket with PCB terminals, pinning 5 mm

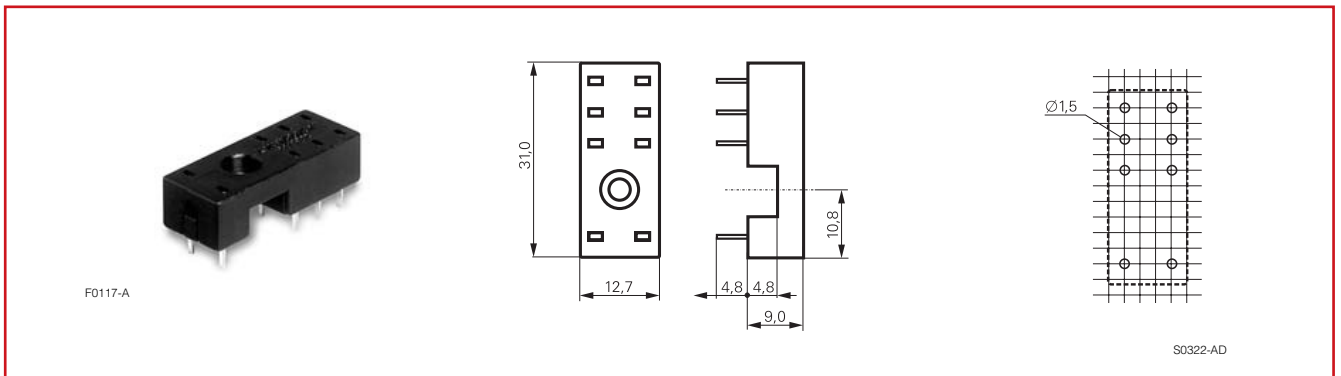

DERATING CURVES

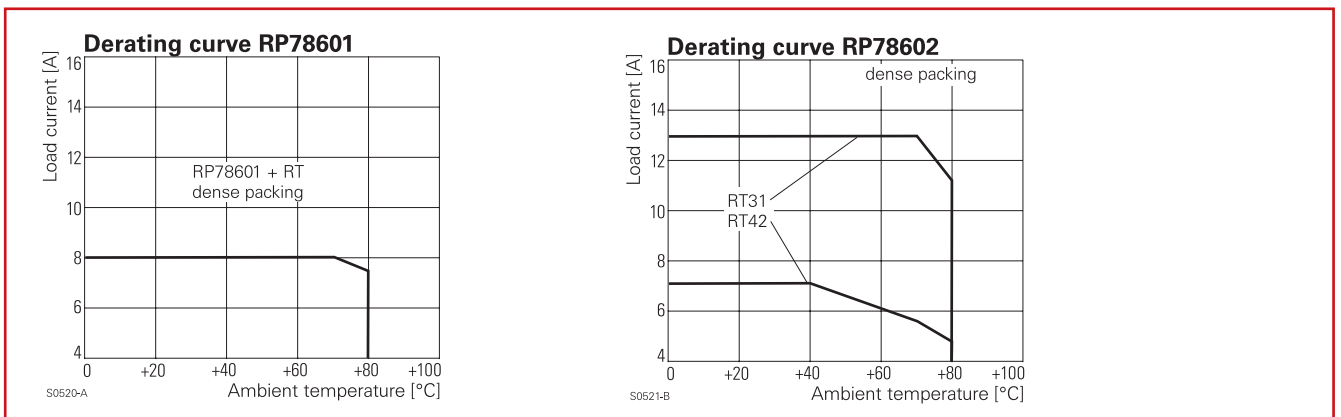

APPROVALS



## TECHNICAL DATA

Technical Data		RP78601 / RP78602
Rated current		12 A *)
Limiting continuous current		see derating curve
Rated voltage / max. switching voltage AC		240 / 400 VAC
Dielectric strength coil-contact circuit		4000 V <sub>rms</sub>
open contact circuit		1000 V <sub>rms</sub>
adjacent contact circuits		2500 V <sub>rms</sub>
Clearance / creepage coil-contact circuit		≧ 10 / 10 mm
Material group of insulation parts		IIIa
Insulation to IEC 60664-1		
Type of insulation coil-contact circuit		reinforced
open contact circuit		functional
adjacent contact circuits		functional
Rated insulation voltage		250 V
Pollution degree		2
Rated voltage system		230/400 V
Overvoltage category		III
RoHS-Directive 2002/95/EC		compliant
Protection DIN 40050		IP20
Ambient temperature range		-40...+80°C
Terminals		pcb
Insertion cycles		A (10)
Max. Insertion Force total		100 N
Mounting distance		≧ 0, dense packing
Resistance to soldering heat		270°C / 10 s
Weight		3g
Packaging unit		100 pcs

\*) For 1 pole relays (16 A) the relay terminals 11-21, 12-22 and 14-24 have to be bridged on the PCB.

### Socket with PCB terminals

Type		Order No.
<b>RP78601</b>	Socket with PCB terminals, pinning 3.5 mm	RP78601
<b>RP78602</b>	Socket with PCB terminals, pinning 5 mm	RP78602

### Accessories for RP78601, RP78602

Type		Order No.
<b>RT16041</b>	Plastic retaining clip RT, relay height 15.7 mm	RT16041
<b>RT28516</b>	Metal retaining clip RT, relay height 15.7 mm	RT28516
<b>RP16100</b>	Metal retaining clip RT, relay height 25.2 mm	RP16100